

High Precision,
Digital Pressure Switch

Series ZSE40/ISE40



ZSE□
ISE□

PSE

ZSE3

PS

ZSE₁
ISE₂

ZSP

ISA2

IS□

ZSM

PF2□

IF□

Data

High precision/High resolution

Vacuum pressure 1/1000 (0.1kPa)

Compound pressure 1/2000 (0.1kPa)

Positive pressure 1/1000 (0.001MPa)



High speed response: 2.5 ms or less

With anti-chattering function

Stable switch output is possible even with sudden

Anti-chattering function

Devices such as large bore cylinders and high-flow vacuum ejectors consume a large volume of air when they operate, and this may cause a momentary drop in the primary pressure. This function prevents such momentary pressure drops from being detected as abnormal pressures by allowing the response time selection to be changed.

[Selectable response times: t]

2.5 ms (normal), 24 ms, 192 ms or 768 ms

The normal setting is selected when shipped from the factory.

(Operating principle)

The pressure values measured within the user-selected response time are averaged, and switch output (ON/OFF) is determined by comparing this averaged pressure value with the set pressure.

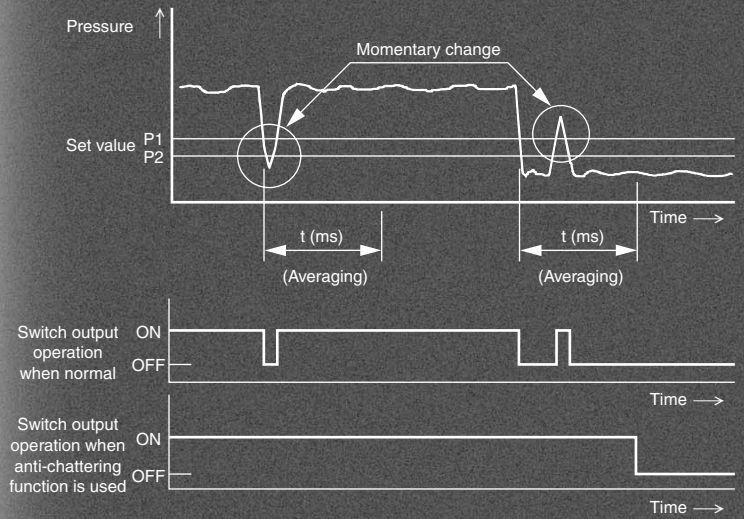

With auto shift function

Allows switch output unaffected by variations in primary pressure.

Auto shift function

Erroneous operation may occur if there is fluctuation in the primary pressure.

The auto shift function compensates for pressure changes to ensure proper ON/OFF switch response during such fluctuations.

(Operating principle)

At the point when the primary pressure fluctuates, the set pressure value is compensated by setting the auto shift input (external input) to low (no-voltage) input, using the pressure measured at that point as a standard.

Without using auto shift

When the primary pressure fluctuates, a correct determination becomes impossible.

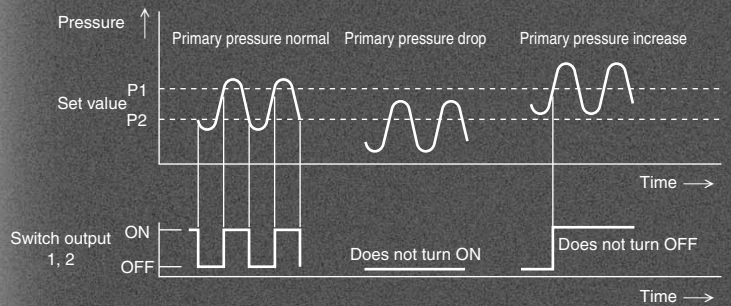

When using auto shift

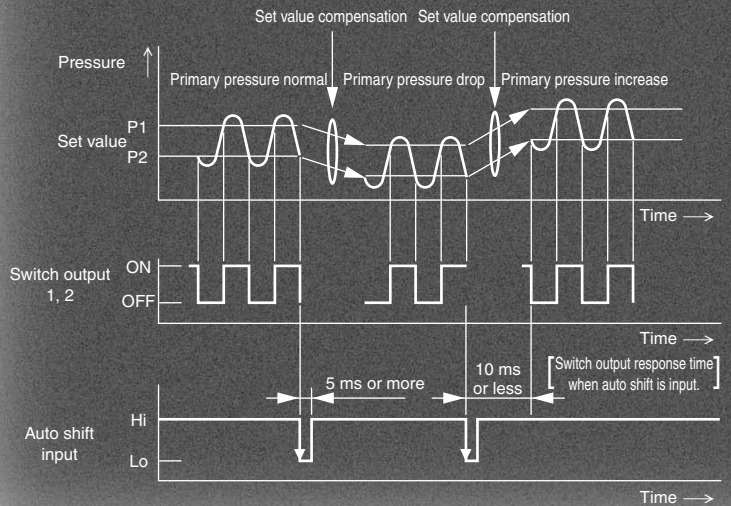

Compound pressure (ZSE40F)

Able to detect suction pressure (vacuum pressure) and release pressure (positive pressure) with a single pressure switch.

3 types of piping

Different piping methods are possible to accommodate the installation location.



Repeatability

$\pm 0.2\%$ F.S. ± 1 digit or less

IP65 compatible

Dusttight/Splash proof type

High Precision, Digital Pressure Switch Series ZSE40/ISE40

How to Order

Set pressure range

Nil	-0.100 to 1.000 MPa	For positive pressure
-----	---------------------	-----------------------

For positive pressure

ISE40

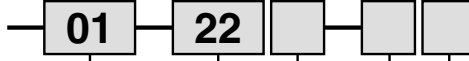

For vacuum/compound pressure

ZSE40

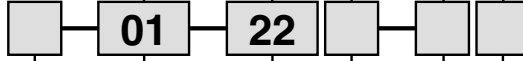

Set pressure range

Nil	10.0 to -101.3 kPa	For vacuum pressure
F	-100.0 to 100.0 kPa	For compound pressure

Piping specifications

<p>01: R 1/8 (With M5 female threads) T1: NPT 1/8 (With M5 female threads)</p>	<p>W1: Rc 1/8</p> <p>Reverse pressure two directions</p>
<p>* C4: With ø4 One-touch fitting * C6: With ø6 One-touch fitting</p> <p>Wall mount</p>	<p>* M5: M5 x 0.8 (Female threads)</p> <p>Wall mount</p>

* Option

Input/Output specifications

22	NPN open collector 2 outputs + analog output
30 *	NPN open collector 2 outputs + auto shift input
62 *	PNP open collector 2 outputs + analog output
70 *	PNP open collector 2 outputs + auto shift input

* Option

Note

When equipped with auto shift function, the following ranges can be set.

Set pressure range	Setting range
-100.0 to 100.0 kPa	-100.0 to 100.0 kPa
10.0 to -101.3 kPa	-101.3 to 101.3 kPa
-0.1 to 1.000 MPa	-1.000 to 1.000 MPa

Option

Nil	None
A	Bracket A (ZS-24-A)
B	Bracket B (ZS-24-B)
E	Panel mount (ZS-22-A)
F	Panel mount (ZS-24-C) + Front protective cover

* When optional parts only are required, order with the part numbers inside ().

Unit specifications

Nil	With unit switching function <small>Note1)</small>
M	SI unit only <small>Note 2)</small>

Note 1) This will no longer be sold for use in Japan after the new Weight and Measure Act is implemented (October, 1999).

Note 2) Fixed unit
For vacuum/compound pressure: kPa
For positive pressure: MPa

Lead wire length

Nil	0.6 m
L	3 m

ZSE□
ISE□

PSE

ZSE3

PS

ZSE1
ZSE2

ZSP

ISA2

IS□

ZSM

PF2□

IF□

Data

Series ZSE40/ISE40

Specifications

	ZSE40F (Compound pressure)	ZSE40 (Vacuum pressure)	ISE40 (Positive pressure)
Rated pressure range	-100.0 to 100.0 kPa	0.0 to -101.3 kPa	0.000 to 1.000 MPa
Operating pressure range/Set pressure range	-100.0 to 100.0 kPa	10.0 to -101.3 kPa	-0.100 to 1.000 MPa
Withstand pressure	500 kPa		1.5 MPa
Set pressure resolution <small>Note 1)</small>	kPa	0.1	—
	MPa	—	0.001
	kgf/cm ²	0.001	0.01
	bar	0.001	0.01
	psi	0.02	0.01
	mmHG	1	—
	InHg	0.1	—
Applicable fluid	Air, Non-corrosive/Non-flammable gas		
Power supply voltage	12 to 24 VDC $\pm 10\%$, Ripple (p-p) 10% or less		
Current consumption	55 mA or less		
Switch output	NPN or PNP 2 outputs	Max. load current : 80 mA Max. applied voltage: 30 VDC (With NPN output) Residual voltage : 1 V or less (With 80 mA load current)	
Repeatability	$\pm 0.2\%$ F.S. ± 1 digit or less		
Hysteresis	Hysteresis mode	Variable	
	Window comparator mode	Fixed (3 digits) <small>Note 4)</small>	
Response time (With anti-chattering function)	2.5 ms or less (With anti-chattering function: 24 ms, 192 ms and 768 ms selections)		
Output short circuit protection	Yes		
Display	3 1/2 digit LED display (Sampling cycle: 5 times/sec.)		
Display accuracy	$\pm 2\%$ F.S. ± 1 digit or less (at ambient temperature of 25 $\pm 3^\circ\text{C}$)		
Indicator light	Green LED (OUT1: Lights when ON), Red LED (OUT2: Lights when ON)		
Analog output <small>Note 2)</small>	Output voltage: 1 to 5 V $\pm 5\%$ F.S. or less (in rated pressure range) Linearity: $\pm 1\%$ F.S. or less Output impedance: Approx. 1 k Ω	Output voltage: 1 to 5 V $\pm 2.5\%$ F.S. or less (in rated pressure range) Linearity: $\pm 1\%$ F.S. or less Output impedance: Approx. 1 k Ω	
Auto shift input <small>Note 3)</small>	No-voltage input (Reed or solid state), input 5 ms or more		
Environmental resistance	Enclosure	IP65	
	Ambient temperature range	Operating: 0 to 50 $^\circ\text{C}$, Stored: -10 to 60 $^\circ\text{C}$ (No condensation or freezing)	
	Ambient humidity range	Operating/Stored: 35 to 85% RH (No condensation)	
	Withstand voltage	1000 VAC for 1 min. between lead wires and body	
	Insulation resistance	50 M Ω or more (at 500 VDC) between lead wires and body	
	Vibration resistance	10 to 500 Hz at the smaller of amplitude 1.5 mm or acceleration 98 m/s ² (10 G) in X, Y, Z directions for 2 hrs. each (De-energized)	
Impact resistance	980 m/s ² (100 G) in X, Y, Z directions 3 times each (De-energized)		
Temperature characteristics	In a temperature range of 0 to 50 $^\circ\text{C}$, $\pm 2\%$ F.S. or less of pressure measured at 25 $^\circ\text{C}$		
Port size	01: R 1/8, M5 x 0.8, T1: NPT 1/8, M5 x 0.8, W1: Rc 1/8 C4: With $\phi 4$ One-touch fitting, C6: With $\phi 6$ One-touch fitting, M5: M5 female threads		
Lead wire	5-wire oil resistant heavy-duty cord (0.15 mm ²)		
Weight	01/T1 types approx. 60 g, W1 type approx. 80 g, C4/C6/M5 types approx. 92 g (Each including 0.6 m lead wires)		

Note 1) Equipped with unit switching function
(Types without the unit switching function use SI units (kPa or MPa) only.)

Note 2) For ZSE40 (F)/ISE40-□-22(L)-(M)

Note 3) For ZSE40 (F)/ISE40-□-30(L)-(M)

Note 4) For ZSE40F (compound pressure) with "psi" indication, this is 0.03 to 0.04 psi.

Note 5) For ZSE40F (compound pressure) with "psi" indication, zero clear is in the range of ± 0.01 psi.

Note)

When equipped with auto shift function, the following ranges can be set.

Set pressure range	Setting range
-100.0 to 100.0 kPa	-100.0 to 100.0 kPa
10.0 to -101.3 kPa	-101.3 to 101.3 kPa
-0.1 to 1.000 MPa	-1.000 to 1.000 MPa

Example of Internal Circuit and Wiring

**ZSE40(F)
ISE40-□-22(L)-(M)
With analog output**

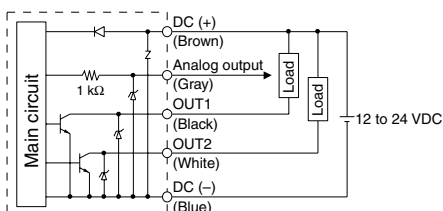

**ZSE40(F)
ISE40-□-62(L)-(M)
With analog output**

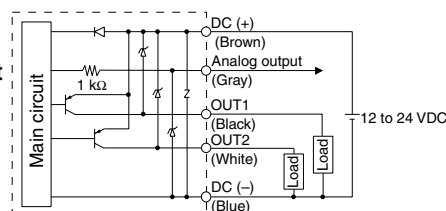

**ZSE40(F)
ISE40-□-30(L)-(M)
With auto shift input**

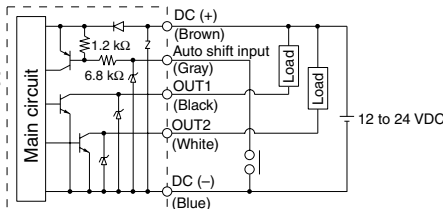

**ZSE40(F)
ISE40-□-70(L)-(M)
With auto shift input**

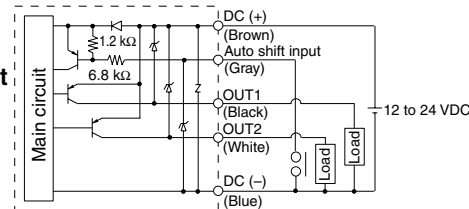

Description

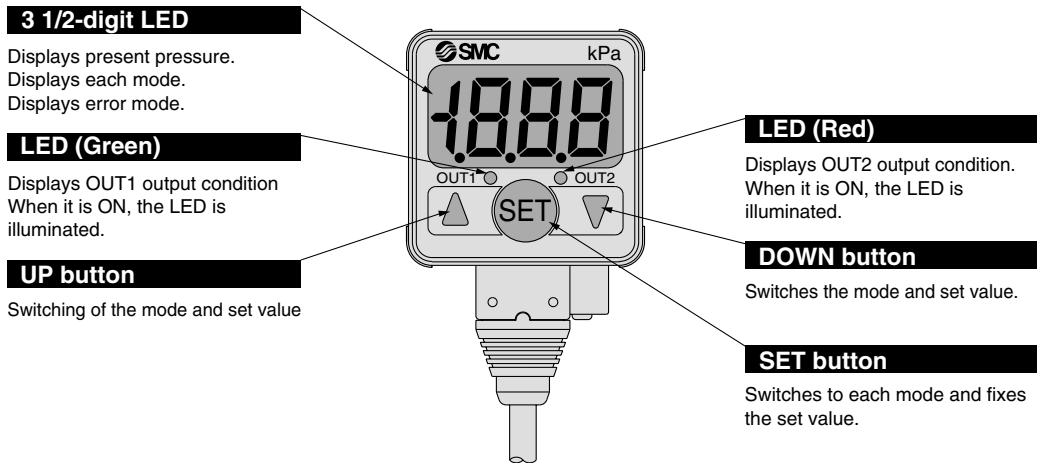

Calibration Procedures

Setting procedure

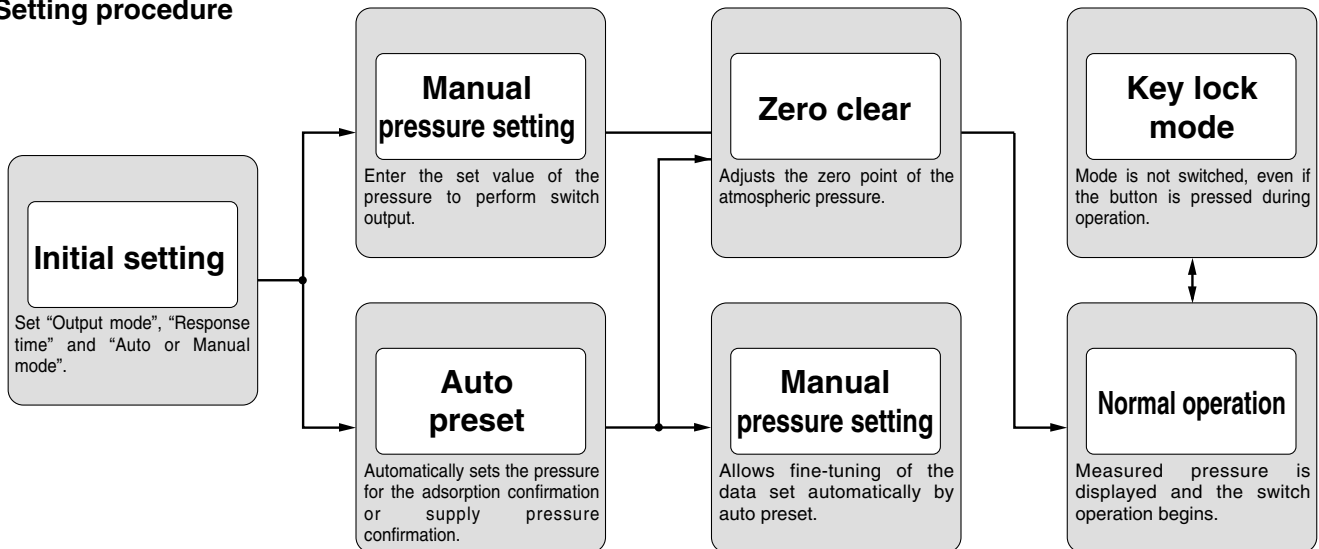

- ZSE
- ISE
- PSE
- ZSE3
- PS
- ZSE1
- ZSP
- ISA2
- IS
- ZSM
- PF2
- IF
- Data

Series ZSE40/ISE40

Calibration Procedures

Initial Setting

1. Initial condition mode



Press the "SET" button for more than 2 seconds until "1no" is displayed. Release it when the display turns to "1nc".

Unit mode: When using a product with a unit switching function, refer to the next page for unit-setting (for overseas).

2. Selection of output mode OUT1

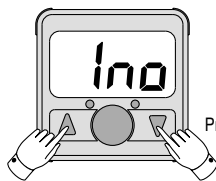

Select the "output mode" for OUT1 by pressing either ▲ button or ▼ button.
 "1no" Normally open mode
 "1nc" Normally closed mode

3. Selection of output mode OUT2

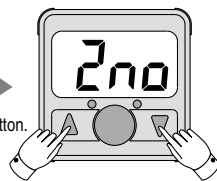

Select the "output mode" for OUT2 by pressing either ▲ button or ▼ button.
 "2no" Normally open mode
 "2nc" Normally closed mode

4. Selection of response time

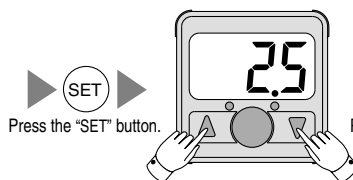

Select the response time by pressing either ▲ button or ▼ button.
 ("2.5": 2.5 ms, "2.4": 24 ms,
 "192": 192 ms, "768": 768 ms)
 Select among them.)

5. Setting Auto/Manual

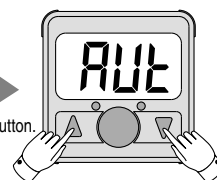

Select "Auto preset mode" or "Manual set mode" by pressing either ▲ button or ▼ button.
 "AUT" Auto preset mode
 "MAN" Manual set mode

Manual Pressure Setting

Output mode differs by the pressure set value.

1. Manual set mode



Select the manual set mode in the initial condition mode and press the "SET" button until "P_1" or "n_1" is displayed.

2. Input set point value for OUT1 (1)



▲ button: Increases set value
 ▼ button: Decreases set value
 Displays the set values "P_1" or "n_1" alternately.

3. Input set point value for OUT1 (2)

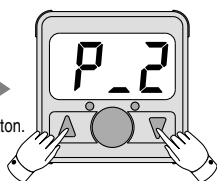

▲ button: Increases set value
 ▼ button: Decreases set value
 Displays the set values "P_2" or "n_2" alternately.

4. Input set point value for OUT2 (1)

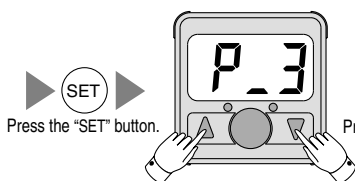

▲ button: Increases set value
 ▼ button: Decreases set value
 Displays the set values "P_3" or "n_3" alternately.

5. Input set point value for OUT2 (2)

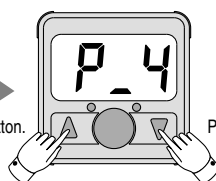

▲ button: Increases set value
 ▼ button: Decreases set value
 Displays the set values "P_4" or "n_4" alternately.

6. Display of setting auto shift

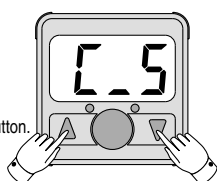

※ Only for ZSE40(F)/ISE40-□-30/70(L)-M, displays the input mode "C_5" and the compensation value alternately. If auto shift input is not complete, zero is displayed.

Unit Set

It's only subject to ZSE40(F)/ISE40-□-□(L).

Unit selection



Set the unit by either ▲ button or ▼ button.
 PPa: kPa or MPa, ρF: kgf/cm²,
 bPa: bar, P5: psi,
 inHg: inHg, mmHg: mmHg



OUT1: Selection of the output mode

Output Type

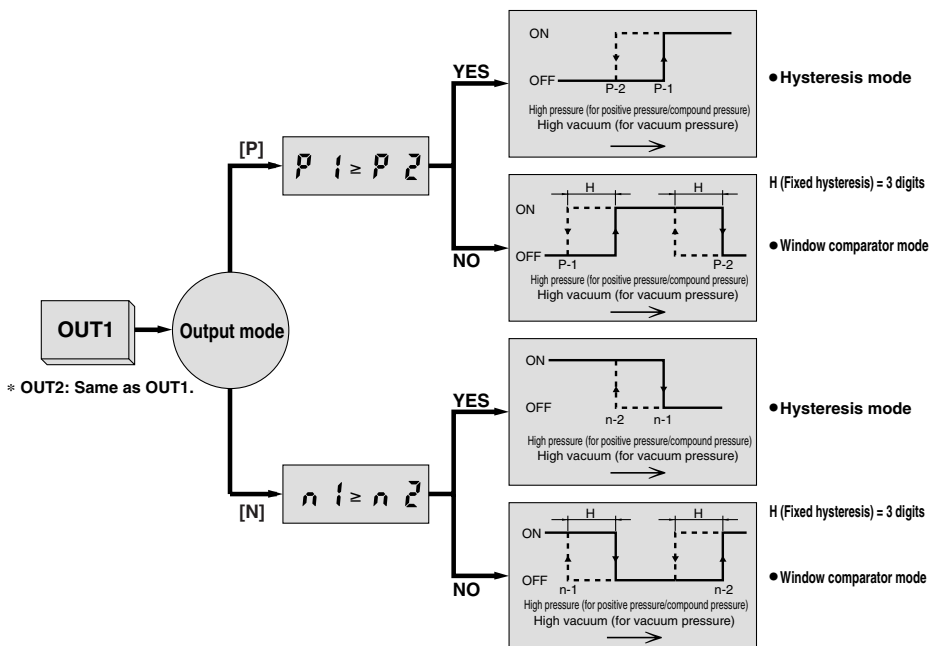

Auto Preset (For adsorption confirmation)

1. Auto preset mode



Select the Auto preset mode in the initial setting mode and press the "SET" button until "RP1" is displayed.

2. Preparation for auto preset



Prepare the equipment for use under operating conditions. When setting OUT1 is not required, press both the ▲ button and ▼ button simultaneously in this state to skip to "RP2".

3. Auto preset of OUT1

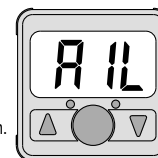

Repeat adsorption and non-adsorption several times in this state. The optimal set value is determined automatically.

4. Preparation for auto preset

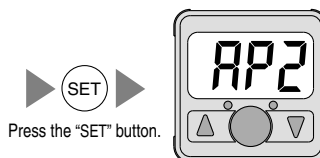

Press the "SET" button.

5. Auto preset of OUT2

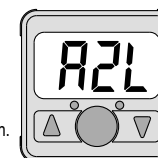

Press the "SET" button to complete the setting.

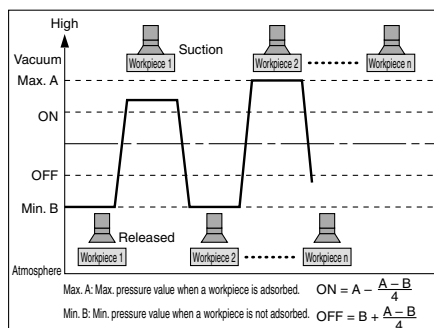

Supplies vacuum pressure, changing the condition of a workpiece by adsorption nozzle, etc. When setting OUT2 is not required, press both the ▲ button and ▼ button simultaneously in this state to skip to the measurement mode.

Repeat adsorption and non-adsorption several times in this state. The optimum set value is determined automatically.

- ZSE□
- ISE□
- PSE
- ZSE3
- PS
- ZSE1
- ZSE2
- ZSP
- ISA2
- IS□
- ZSM
- PF2□
- IF□
- Data

Series ZSE40/ISE40

Calibration Procedures

Auto Preset (In the case of confirming the supply pressure)

1. Auto preset mode



Select the Auto preset mode in the initial setting mode and press the "SET" button until "RP 1" is displayed.

2. Preparation for auto preset



Prepare the equipment for use under operating conditions. When setting OUT1 is not required, press both the ▲ button and ▼ button simultaneously in this state to skip to "RP 2".

3. Auto preset of OUT1

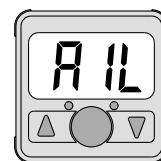

The pressure is read and the optimal set value is determined automatically.

Press the "SET" button.

4. Preparation for auto preset



Prepare the equipment for use under operating conditions of OUT2.

When setting OUT2 is not required, press both the ▲ button and ▼ button simultaneously in this state to skip to the measurement mode.

5. Auto preset of OUT2



The pressure is read and the optimal set value is determined automatically.

Press the "SET" button.

Press the "SET" button.

Press the "SET" button to complete the setting.

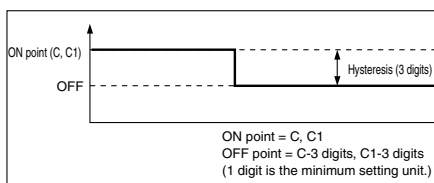

Other Functions

- **Key lock mode** ----- Used to avoid a malfunction when buttons on the front part of the switch are pressed.

Initiate key lock

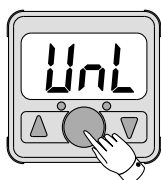

Press the "SET" button for 4 seconds or longer. Release it when the display turns to "UnL".

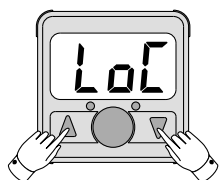

Display "LoL" by pressing ▲ button or ▼ button.

Press the "SET" button to complete the setting.

Release key lock



Press the "SET" button for 4 seconds or longer. Release it when the display turns to "UnL".

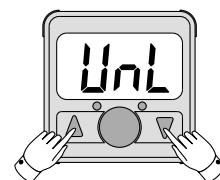

Display "UnL" by pressing ▲ button or ▼ button.

Press the "SET" button to complete the setting.

- **Peak mode** ----- Allows holding of the maximum pressure value on display under measurement.

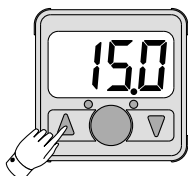

While displayed, pressing the ▲ button for 1 second or longer causes the peak mode to display and blink.

Pressing the ▲ button once again for 1 second or longer reinstates it.

Note) Displaying the peak and the bottom display is not distinguished.

- **Bottom mode** ----- Allows holding of the minimum pressure value on display under measurement.



While displayed, pressing the ▼ button for 1 second or longer causes the bottom mode to display and blink.

Pressing the ▼ button once again for 1 second or longer reinstates it.

Note) Displaying the peak and the bottom display is not distinguished.

- **Zero clear** ----- Allows an adjust to zero on the display if the pressure to be measured is within a range of ±70 digits from the atmospheric pressure.

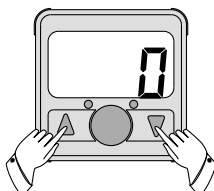

Pressing the ▲ + ▼ buttons simultaneously with the supply pressure released to the atmosphere, causes it to reset to zero on the display and completes the zero clear operation. The function then returns to the measurement mode.

High Precision, Digital Pressure Switch Series ZSE40/ISE40

Dimensions

ZSE40(F)/ISE40-01

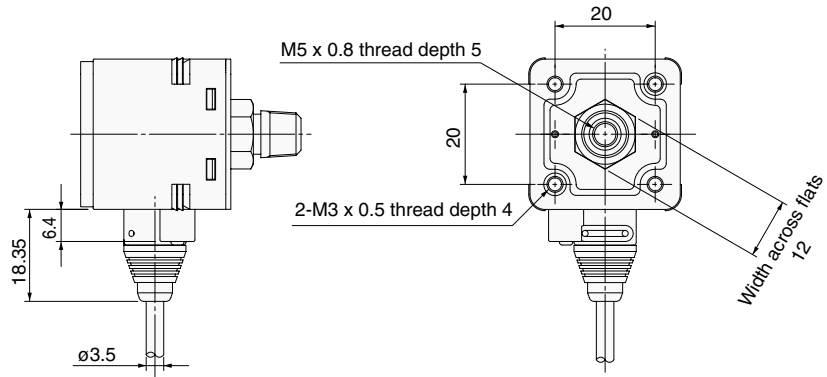
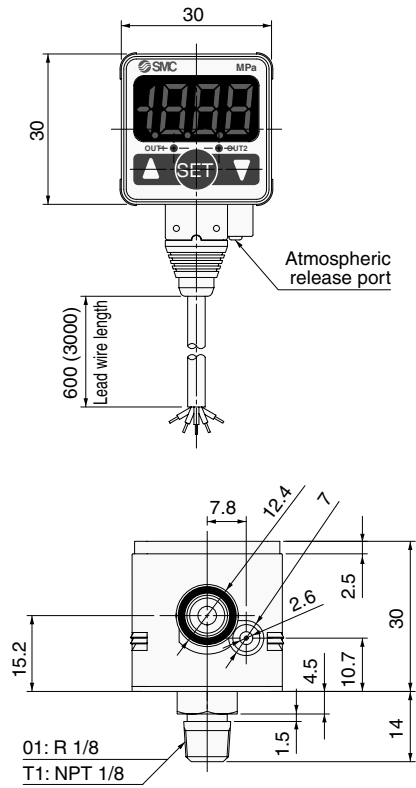
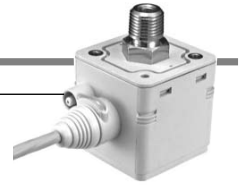

* For splash proof use (IP65), insert an air tube into the atmospheric release port.
(Refer to "Precautions" on page 16-2-24 for details.)

ZSE40(F)/ISE40-W1

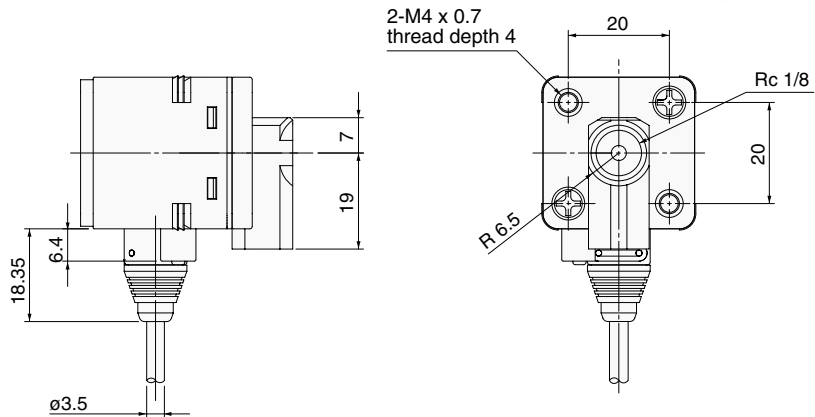
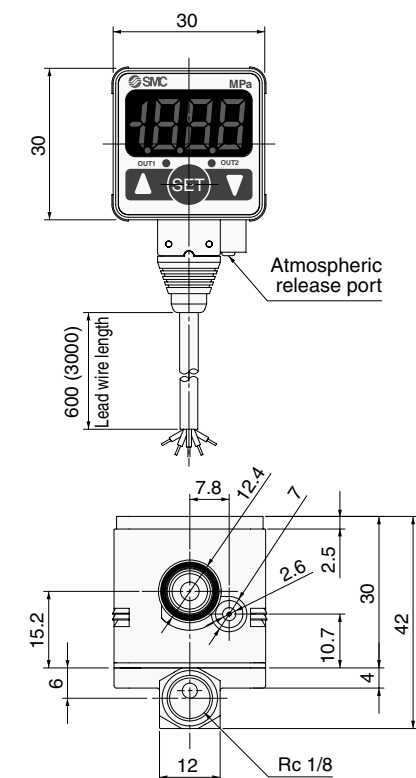
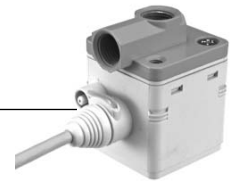

* For splash proof use (IP65), insert an air tube into the atmospheric release port.
(Refer to "Precautions" on page 16-2-24 for details.)

- ZSE□
- ISE□
- PSE
- ZSE3
- PS
- ZSE1₂
- ZSP
- ISA2
- IS□
- ZSM
- PF2□
- IF□
- Data

Series ZSE40/ISE40

Dimensions

ZSE40(F)/ISE40—C4
C6
M5

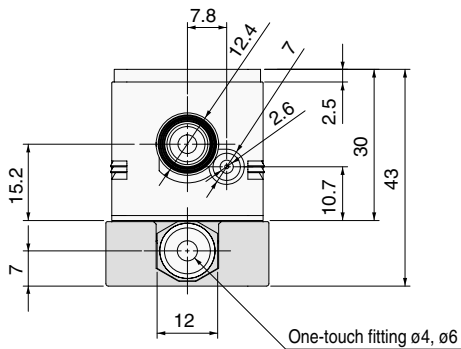
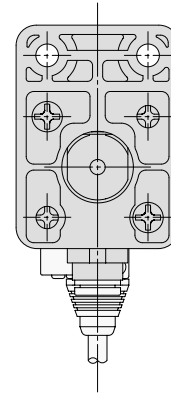
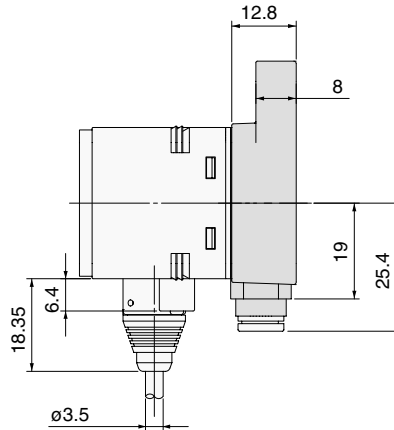
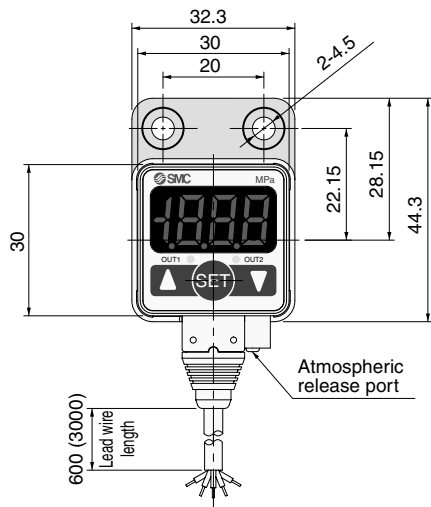

For—M5

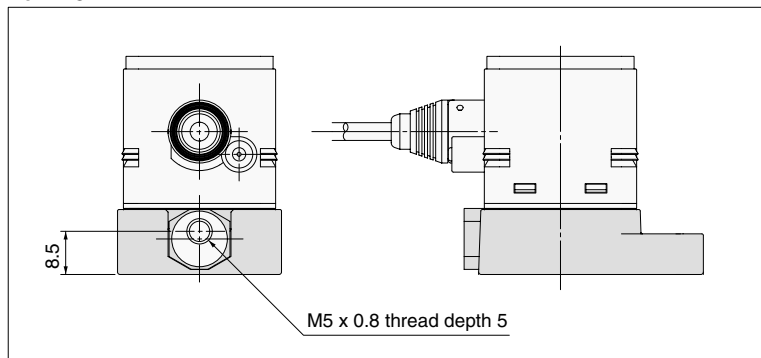

* For splash proof use (IP65), insert an air tube into the atmospheric release port.
(Refer to "Precautions" for details.)

⚠ Precautions

⚠ Caution

1. Immediately after supplying power, there is drift of about $\pm 0.5\%$ F.S. When used with very low pressure, allow the unit to warm up for about 20 to 30 minutes.
2. Do not use in locations where there is splashing or spraying of oils and solvents.
3. When using a commercially available switching regulator, be sure to ground the FG terminal.
4. In locations where the switch is exposed to water and dust, etc., these may enter the switch from the atmospheric release port. Insert $\phi 4$ tubing (inside diameter $\phi 2.5$) into the atmospheric release port, and extend the other end to a safe area where water, etc., is not splashed or sprayed. Be sure that tubing is not bent and holes are not blocked, etc., or it will become impossible to make correct pressure measurements.

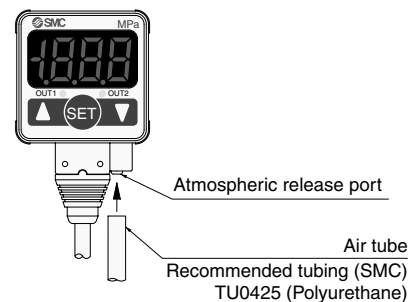





Safety Instructions

These safety instructions are intended to prevent a hazardous situation and/or equipment damage. These instructions indicate the level of potential hazard by labels of "Caution", "Warning" or "Danger". To ensure safety, be sure to observe ISO 4414 ^{Note 1)}, JIS B 8370 ^{Note 2)} and other safety practices.

 **Caution** : Operator error could result in injury or equipment damage.

 **Warning** : Operator error could result in serious injury or loss of life.

 **Danger** : In extreme conditions, there is a possible result of serious injury or loss of life.

Note 1) ISO 4414: Pneumatic fluid power--General rules relating to systems.

Note 2) JIS B 8370: General Rules for Pneumatic Equipment

Warning

1. The compatibility of pneumatic equipment is the responsibility of the person who designs the pneumatic system or decides its specifications.

Since the products specified here are used in various operating conditions, their compatibility for the specific pneumatic system must be based on specifications or after analysis and/or tests to meet your specific requirements. The expected performance and safety assurance will be the responsibility of the person who has determined the compatibility of the system. This person should continuously review the suitability of all items specified, referring to the latest catalog information with a view to giving due consideration to any possibility of equipment failure when configuring a system.

2. Only trained personnel should operate pneumatically operated machinery and equipment.

Compressed air can be dangerous if an operator is unfamiliar with it. Assembly, handling or repair of pneumatic systems should be performed by trained and experienced operators.

3. Do not service machinery/equipment or attempt to remove components until safety is confirmed.

1. Inspection and maintenance of machinery/equipment should only be performed once measures to prevent falling or runaway of the driver objects have been confirmed.
2. When equipment is to be removed, confirm the safety process as mentioned above. Cut the supply pressure for this equipment and exhaust all residual compressed air in the system.
3. Before machinery/equipment is restarted, take measures to prevent shooting-out of cylinder piston rod, etc.

4. Contact SMC if the product is to be used in any of the following conditions:

1. Conditions and environments beyond the given specifications, or if product is used outdoors.
2. Installation on equipment in conjunction with atomic energy, railway, air navigation, vehicles, medical equipment, food and beverages, recreation equipment, emergency stop circuits, clutch and brake circuits in press applications, or safety equipment.
3. An application which has the possibility of having negative effects on people, property, or animals, requiring special safety analysis.



Common Precautions

Be sure to read before handling.

For detailed precautions on every series, refer to main text.

Selection

Warning

1. Confirm the specifications.

Products represented in this catalog are designed for use in compressed air applications only (including vacuum), unless otherwise indicated.

Do not use the product outside their design parameters.

Please contact SMC when using the products in applications other than compressed air (including vacuum).

Mounting

Warning

1. Instruction manual

Install the products and operate them only after reading the instruction manual carefully and understanding its contents. Also keep the manual where it can be referred to as necessary.

2. Securing the space for maintenance

When installing the products, please allow access for maintenance.

3. Tightening torque

When installing the products, please follow the listed torque specifications.

Piping

Caution

1. Before piping

Make sure that all debris, cutting oil, dust, etc., are removed from the piping.

2. Wrapping of pipe tape

When screwing piping or fittings into ports, ensure that chips from the pipe threads or sealing material do not get inside the piping. Also, when the pipe tape is used, leave 1.5 to 2 thread ridges exposed at the end of the threads.

Air Supply

Warning

1. Operating fluid

Please consult with SMC when using the product in applications other than compressed air (including vacuum).

Regarding products for general fluid, please ask SMC about applicable fluids.

2. Install an air dryer, aftercooler, etc.

Excessive condensate in a compressed air system may cause valves and other pneumatic equipment to malfunction.

Installation of an air dryer, after cooler etc. is recommended.

3. Drain flushing

If condensate in the drain bowl is not emptied on a regular basis, the bowl will over flow and allow the condensate to enter the compressed air lines.

If the drain bowl is difficult to check and remove, it is recommended that a drain bowl with the auto-drain option be installed.

For compressed air quality, refer to "Air Preparation Equipment" catalog.

4. Use clean air

If the compressed air supply is contaminated with chemicals, synthetic materials, corrosive gas, etc., it may lead to break down or malfunction.

Operating Environment

Warning

1. Do not use in environments where the product is directly exposed to corrosive gases, chemicals, salt water, water or steam.

2. Do not expose the product to direct sunlight for an extended period of time.

3. Do not use in a place subject to heavy vibrations and/or shocks.

4. Do not mount the product in locations where it is exposed to radiant heat.

Maintenance

Warning

1. Maintenance procedures are outlined in the operation manual.

Not following proper procedures could cause the product to malfunction and could lead to damage to the equipment or machine.

2. Maintenance work

If handled improperly, compressed air can be dangerous.

Assembly, handling and repair of pneumatic systems should be performed by qualified personnel only.

3. Drain flushing

Remove drainage from air filters regularly. (Refer to the specifications.)

4. Shut-down before maintenance

Before attempting any kind of maintenance make sure the supply pressure is shut of and all residual air pressure is released from the system to be worked on.

5. Start-up after maintenance and inspection

Apply operating pressure and power to the equipment and check for proper operation and possible air leaks. If operation is abnormal, please verify product set-up parameters.

6. Do not make any modifications to be product.

Do not take the product apart.

Quality Assurance Information (ISO 9001, ISO 14001)

Reliable quality of products in the global market

To enable our customers throughout the world to use our products with even greater confidence, SMC has obtained certification for international standards “ISO 9001” and “ISO 14001”, and created a complete structure for quality assurance and environmental controls. SMC products pursue to meet its customers’ expectations while also considering company’s contribution in society.

Quality management system ISO 9001

This is an international standard for quality control and quality assurance. SMC has obtained a large number of certifications in Japan and overseas, providing assurance to our customers throughout the world.



Environmental management system ISO 14001

This is an international standard related to environmental management systems and environmental inspections. While promoting environmentally friendly automation technology, SMC is also making diligent efforts to preserve the environment.



SMC’s quality control system



Quality policies

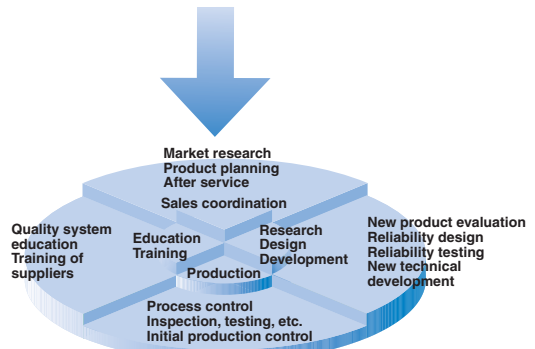

Quality control activities

SMC Product Conforming to Inter

SMC products complying with EN/ISO, CSA/UL standards are supporting



The CE mark indicates that machines and components meet essential requirements of all the EC Directives applied.

It has been obligatory to apply CE marks indicating conformity with EC Directives when machines and components are exported to the member Nations of the EU.

Once "A manufacturer himself" declares a product to be safe by means of CE marking (declaration of conformity by manufacturer), free distribution inside the member Nations of the EU is permissible.

■ CE Mark

SMC provides CE marking to products to which EMC and Low Voltage Directives have been applied, in accordance with CETOP (European hydraulics and pneumatics committee) guide lines.

■ As of February 1998, the following 18 countries will be obliged to conform to CE mark legislation

Iceland, Ireland, United Kingdom, Italy, Austria, Netherlands, Greece, Liechtenstein, Sweden, Spain, Denmark, Germany, Norway, Finland, France, Belgium, Portugal, Luxembourg

■ EC Directives and Pneumatic Components

• Machinery Directive

The Machinery Directive contains essential health and safety requirements for machinery, as applied to industrial machines e.g. machine tools, injection molding machines and automatic machines. Pneumatic equipment is not specified in Machinery Directive. However, the use of SMC products that are certified as conforming to EN Standards, allows customers to simplify preparation work of the Technical Construction File required for a Declaration of Conformity.

• Electromagnetic Compatibility (EMC) Directive

The EMC Directive specifies electromagnetic compatibility. Equipment which may generate electromagnetic interference or whose function may be compromised by electromagnetic interference is required to be immune to electromagnetic affects (EMS/immunity) without emitting excessive electromagnetic affects (EMI/emission).

• Low Voltage Directive

This directive is applied to products, which operate above 50 VAC to 1000 VAC and 75 VDC to 1500 VDC operating voltage, and require electrical safety measures to be introduced.

• Simple Pressure Vessels Directive

This directive is applied to welded vessels whose maximum operating pressure (PS) and volume of vessel (V) exceed 50 bar/L. Such vessels require EC type examination and then CE marking.

national Standards

you to comply with EC directives and CSA/UL standards.



■ CSA Standards & UL Standards

UL and CSA standards have been applied in North America (U.S.A. and Canada) symbolizing safety of electric products, and are defined to mainly prevent danger from electric shock or fire, resulting from trouble with electric products. Both UL and CSA standards are acknowledged in North America as the first class certifying body. They have a long experience and ability for issuing product safety certificate. Products approved by CSA or UL standards are accepted in most states and governments beyond question.

Since CSA is a test certifying body as the National Recognized Testing Laboratory (NRTL) within the jurisdiction of Occupational Safety and Health Administration (OSHA), SMC was tested for compliance with CSA Standards and UL Standards at the same time and was approved for compliance with the two Standards. The above CSA NRTL/C logo is described on a product label in order to indicate that the product is approved by CSA and UL Standards.

■ TSSA (MCCR) Registration Products

TSSA is the regulation in Ontario State, Canada. The products that the operating pressure is more than 5 psi (0.03 MPa) and the piping size is bigger than 1 inch. fall into the scope of TSSA regulation.

Products conforming to CE Standard



With CE symbol for simple visual recognition

In this catalog each accredited product series is indicated with a CE mark symbol. However, in some cases, every available models may not meet CE compliance. Please visit our web site for the latest selection of available models with CE mark.

<http://www.smcworld.com>

SMC's Global Service Network

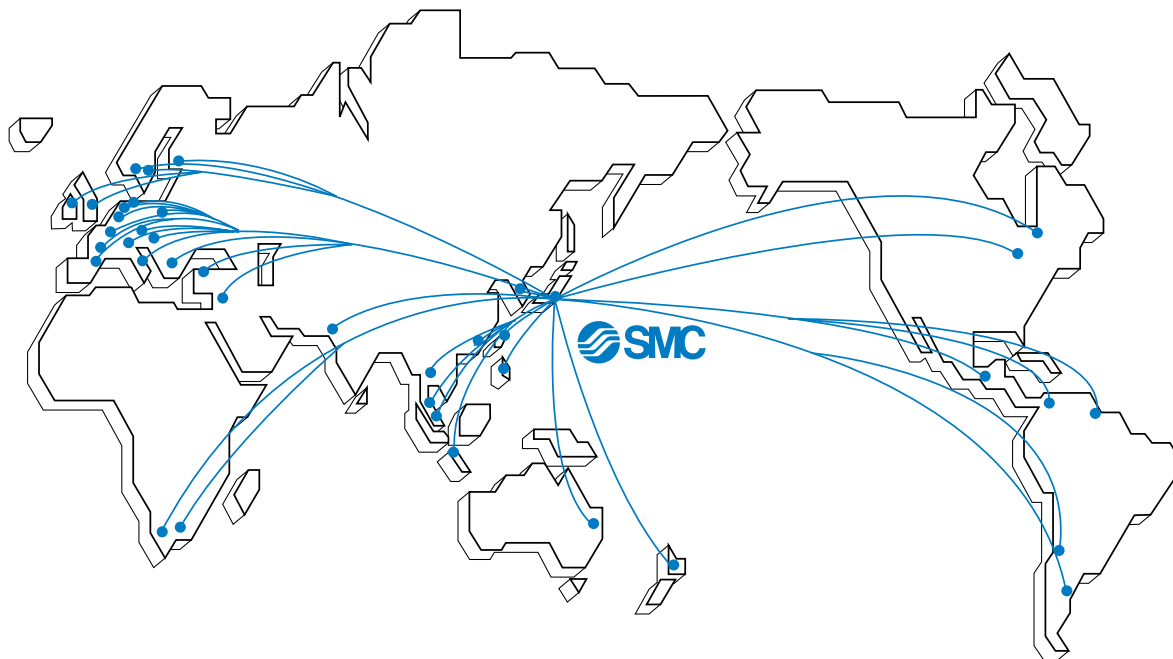

America

U.S.A. **SMC Corporation of America**

3011 North Franklin Road Indianapolis, IN 46226, U.S.A.
TEL: 317-899-4440 FAX: 317-899-3102

CANADA **SMC Pneumatics (Canada) Ltd.**

6768 Financial Drive Mississauga, Ontario, L5N 7J6 Canada
TEL: 905-812-0400 FAX: 905-812-8686

MEXICO **SMC Corporation (Mexico), S.A. DE C.V.**

Carr. Silao-Trejo K.M. 2.5 S/N, Predio San Jose del Duranzo
C.P. 36100, Silao, Gto., Mexico
TEL: 472-72-2-55-00 FAX: 472-72-2-59-44/2-59-46

CHILE **SMC Pneumatics (Chile) S.A.**

Av. La Montaña 1,115 km. 16.5 P. Norte Parque
Industrial Valle Grande, Lampa Santiago, Chile
TEL: 02-270-8600 FAX: 02-270-8601

ARGENTINA **SMC Argentina S.A.**

Teodoro Garcia 3860 (1427) Buenos Aires, Argentina
TEL: 011-4555-5762 FAX: 011-4555-5762

BOLIVIA **SMC Pneumatics Bolivia S.R.L.**

Avenida Beni Numero 4665
Santa Cruz de la Sierra-Casilla de Correo 2281, Bolivia
TEL: 591-3-3428383 FAX: 591-3-3449900

VENEZUELA **SMC Neumatica Venezuela S.A.**

Apartado 40152, Avenida Nueva Granada, Edificio Wanlac,
Local 5, Caracas 1040-A, Venezuela
TEL: 2-632-1310 FAX: 2-632-3871

PERU (Distributor) **IMPECO Automatizacion Industrial S.A.**

AV. Canevaro 752, Lince, Lima, Peru
TEL: 1-471-6002 FAX: 1-471-0935

URUGUAY (Distributor) **BAKO S.A.**

Galicia 1650 esq. Gaboto C.P. 11200, Montevideo, Uruguay
TEL: 2-401-6603 FAX: 2-409-4306

BRAZIL **SMC Pneumaticos Do Brasil Ltda.**

Rua. Dra. Maria Fidelis, nr. 130, Jardim Piraporinha-Diadema-S.P.
CEP: 09950-350, Brasil
TEL: 11-4051-1177 FAX: 11-4071-6636

COLOMBIA (Distributor) **Airmatic Ltda.**

Calle 18 69-05 Apart. Aereo 081045 Santa Fe de Bogotá, Colombia
TEL: 1-424-9240 FAX: 1-424-9260

Europe

U.K. **SMC Pneumatics (U.K.) Ltd.**

Vincent Avenue, Crownhill, Milton Keynes, MK8 0AN, Buckinghamshire, U.K.
TEL: 01908-563888 FAX: 01908-561185

GERMANY **SMC Pneumatik GmbH**

Boschring 13-15 D-63329 Egelsbach, Germany
TEL: 06103-4020 FAX: 06103-402139

ITALY **SMC Italia S.p.A.**

Via Garibaldi 62 I-20061 Carugate Milano, Italy
TEL: 02-9271365 FAX: 02-9271365

FRANCE **SMC Pneumatique S.A.**

1 Boulevard de Strasbourg, Parc Gustave Eiffel, Bussy Saint Georges, F-77600
Marne La Vallee Cedex 3 France
TEL: 01-64-76-10-00 FAX: 01-64-76-10-10

SWEDEN **SMC Pneumatics Sweden AB**

Ekhagsvägen 29-31, S-141 05 Huddinge, Sweden
TEL: 08-603-07-00 FAX: 08-603-07-10

SWITZERLAND **SMC Pneumatik AG**

Dorfstrasse 7, Postfach 117, CH-8484 Weisslingen, Switzerland
TEL: 052-396-3131 FAX: 052-396-3191

AUSTRIA **SMC Pneumatik GmbH (Austria)**

Girakstrasse 8, A-2100 Korneuburg, Austria
TEL: 0-2262-6228-0 FAX: 0-2262-62285

SPAIN **SMC España, S.A.**

Zuazobidea 14 Pol. Ind. Júndiz 01015 Vitoria, Spain
TEL: 945-184-100 FAX: 945-184-510

IRELAND **SMC Pneumatics (Ireland) Ltd.**

2002 Citywest Business Campus, Naas Road, Saggart, Co. Dublin, Ireland
TEL: 01-403-9000 FAX: 01-466-0385

NETHERLANDS (Associated company) **SMC Pneumatics BV**

De Ruyterkade 120, NL-1011 AB Amsterdam, Netherlands
TEL: 020-5318888 FAX: 020-5318880

GREECE (Distributor) **S.Parianopoulos S.A.**

7, Konstantinoupoleos Street 11855 Athens, Greece
TEL: 01-3426076 FAX: 01-3455578

DENMARK **SMC Pneumatik A/S**

Knudsminde 4 B DK-8300
Odder, Denmark
TEL: 70252900 FAX: 70252901

Europe

FINLAND SMC Pneumatics Finland OY

PL72, Tiistiniityntie 4, SF-02231 ESP00, Finland
TEL: 09-8595-80 FAX: 09-8595-8595

NORWAY SMC Pneumatics Norway A/S

Vollsvæien 13C, Granfoss Næringspark N-1366 LYSAKER, Norway
TEL: 67-12-90-20 FAX: 67-12-90-21

BELGIUM (Distributor) SMC Pneumatics N.V./S.A.

Nijverheidsstraat 20 B-2160 Wommelgem Belgium
TEL: 03-355-1464 FAX: 03-355-1466

POLAND SMC Industrial Automation Polska Sp.z.o.o.

ul. Konstruktorska 11A, PL-02-673 Warszawa, Poland
TEL: 022-548-5085 FAX: 022-548-5087

TURKEY (Distributor) Entek Pnömatik San.ve Tic. Ltd. Sti

Perpa Tic. Merkezi Kat:11 No.1625 80270 Okmeydani Istanbul, Türkiye
TEL: 0212-221-1512 FAX: 0212-221-1519

RUSSIA SMC Pneumatik LLC.

36/40 Sredny prospect V.O. St. Petersburg 199004, Russia
TEL: 812-118-5445 FAX: 812-118-5449

CZECH SMC Industrial Automation CZ s.r.o.

Hudcova 78a, CZ-61200 Brno, Czech Republic
TEL: 05-4121-8034 FAX: 05-4121-8034

HUNGARY SMC Hungary Ipari Automatizálási kft.

Budafoki ut 107-113 1117 Budapest
TEL: 01-371-1343 FAX: 01-371-1344

ROMANIA SMC Romania S.r.l.

Str. Frunzei, Nr. 29, Sector 2, Bucharest, Romania
TEL: 01-3205111 FAX: 01-3261489

SLOVAKIA SMC Priemyselná automatizácia, s.r.o.

Nova 3, SK-83103 Bratislava
TEL: 02-4445-6725 FAX: 02-4445-6028

SLOVENIA SMC Industrijska Avtomatila d.o.o.

Grajski trg 15, SLO- 8360 Zuzemberk, Slovenia
TEL: 07388-5240 FAX: 07388-5249

LATVIA SMC Pneumatics Latvia SIA

Šmerļa ielā 1-705, Rīga LV-1006
TEL: 777 94 74 FAX: 777 94 75

SOUTH AFRICA (Distributor) Hyflo Southern Africa (Pty.) Ltd.

P.O.Box 240 Paardeneiland 7420 South Africa
TEL: 021-511-7021 FAX: 021-511-4456

EGYPT (Distributor) Saadani Trading & Ind. Services

15 Sebaai Street, Miami 21411 Alexandria, Egypt
TEL: 3-548-50-34 FAX: 3-548-50-34

Oceania/Asia

AUSTRALIA SMC Pneumatics (Australia) Pty.Ltd.

14-18 Hudson Avenue Castle Hill NSW 2154, Australia
TEL: 02-9354-8222 FAX: 02-9894-5719

NEW ZEALAND SMC Pneumatics (New Zealand) Ltd.

8C Sylvia Park Road Mt.Wellington Auckland, New Zealand
TEL: 09-573-7007 FAX: 09-573-7002

TAIWAN SMC Pneumatics (Taiwan) Co.,Ltd.

17, Lane 205, Nansan Rd., Sec.2, Luzhu-Hsiang, Taoyuan-Hsien, TAIWAN
TEL: 03-322-3443 FAX: 03-322-3387

HONG KONG SMC Pneumatics (Hong Kong) Ltd.

29/F, Clifford Centre, 778-784 Cheung, Sha Wan Road, Lai Chi Kok, Kowloon, Hong Kong
TEL: 2744-0121 FAX: 2785-1314

SINGAPORE SMC Pneumatics (S.E.A.) Pte. Ltd.

89 Tuas Avenue 1, Jurong Singapore 639520
TEL: 6861-0888 FAX: 6861-1889

PHILIPPINES SHOKETSU SMC Corporation

Unit 201 Common Goal Tower, Madrigal Business Park, Ayala Alabang Muntinlupa, Philippines
TEL: 02-8090565 FAX: 02-8090586

MALAYSIA SMC Pneumatics (S.E.A.) Sdn. Bhd.

Lot 36 Jalan Delima1/1, Subang Hi-Tech Industrial Park, Batu 3 40000 Shah Alam Selangor, Malaysia
TEL: 03-56350590 FAX: 03-56350602

SOUTH KOREA SMC Pneumatics Korea Co., Ltd.

Woolim e-BIZ Center (Room 1008), 170-5, Guro-Dong, Guro-Gu, Seoul, 152-050, South Korea
TEL: 02-3219-0700 FAX: 02-3219-0702

CHINA SMC (China) Co., Ltd.

7 Wan Yuan St. Beijing Economic & Technological Development Zone 100176, China
TEL: 010-67882111 FAX: 010-67881837

THAILAND SMC Thailand Ltd.

134/6 Moo 5, Tiwanon Road, Bangkadi, Amphur Muang, Patumthani 12000, Thailand
TEL: 02-963-7099 FAX: 02-501-2937

INDIA SMC Pneumatics (India) Pvt. Ltd.

D-107 to 112, Phase-2, Extension, Noida, Dist. Gautaim Budh Nagar, U.P. 201 305, India
TEL: (0120)-4568730 FAX: 0120-4568933

INDONESIA (Distributor) P.T. Riyadi Putera Makmur

Jalan Hayam Wuruk Komplek Glodok Jaya No. 27-28 Jakarta 11180 Indonesia
TEL: 021-625 5548 FAX: 021-625 5888

PAKISTAN (Distributor) Jubilee Corporation

First Floor Mercantile Centre, Newton Road Near Boulton Market P.O. Box 6165 Karachi 74000 Pakistan
TEL: 021-243-9070/8449 FAX: 021-241-4589

ISRAEL (Distributor) Baccara Automation Control

Kvutza Geva 18915 Israel
TEL: 04-653-5960 FAX: 04-653-1445

SAUDI ARABIA (Distributor) Assaggaff Trading Est.

P.O. Box 3385 Al-Amir Majed Street, Jeddah-21471, Saudi Arabia
TEL: 02-6761574 FAX: 02-6708173